

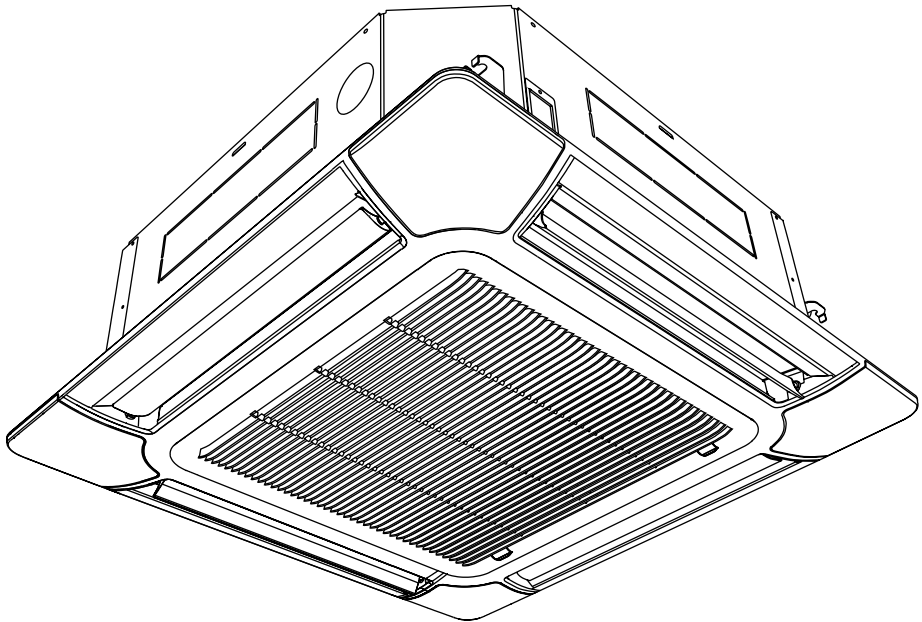

AIR CONDITIONER CASSETTE TYPE

AUT Series



KEEP THIS MANUAL
FOR FUTURE REFERENCE

FUJITSU GENERAL LIMITED

<p>⚠ CAUTION</p> <p>R410A REFRIGERANT</p> <p><small>This Air Conditioner contains and operates with refrigerant R410A.</small></p> <p><small>THIS PRODUCT MUST ONLY BE INSTALLED OR SERVICED BY QUALIFIED PERSONNEL.</small></p> <p><small>Refer to Commonwealth, State, Territory and local legislation, regulations, codes, installation & operation manuals, before the installation, maintenance and/or service of this product.</small></p>
--



P/N9378589025-02

CONTENTS

SAFETY PRECAUTIONS	1	SELF-DIAGNOSIS	9
NAME OF PARTS	2	ADJUSTING THE DIRECTION OF	
PREPARATORY OPERATION	3	AIR CIRCULATION	10
OPERATION	3	SWING OPERATION	10
TIMER FUNCTIONS	5	CLEANING AND CARE	11
ON/OFF TIMER	5	TROUBLESHOOTING	12
WEEKLY TIMER	6	OPERATING TIPS	13
TEMPERATURE SET BACK TIMER	8	TEMPERATURE AND	
FILTER DISPLAY RESET	9	HUMIDITY RANGE	15

SAFETY PRECAUTIONS

- Before using the appliance, read these "SAFETY PRECAUTIONS" thoroughly and operate in the correct way.
- The instructions in this section all relate to safety; be sure to maintain safe operating conditions.
- "DANGER", "WARNING" and "CAUTION" have the following meanings in these instructions:

 DANGER!	This mark indicates procedures which, if improperly performed, are most likely to result in the death of or serious injury to the user or service personnel.
 WARNING!	This mark indicates procedures which, if improperly performed, might lead to the death or serious injury of the user.
 CAUTION!	This mark indicates procedures which, if improperly performed, might possibly result in personal harm to the user, or damage to property.

DANGER!

- Do not attempt to install this air conditioner by yourself.
- This unit contains no user-serviceable parts. Always consult authorized service personnel for repairs.
- When moving, consult authorized service personnel for disconnection and installation of the unit.
- Do not become over-exposed to cold air by staying in the direct path of the airflow of the air conditioner for extended periods of time.
- Do not insert fingers or objects into the outlet port or intake grilles.
- Do not start and stop air conditioner operation by turning off the electrical breaker and so on.
- In the event of a malfunction (burning smell, etc.), immediately stop operation, turn off the electrical breaker, and consult authorized service personnel.

CAUTION!

- Provide occasional ventilation during use.
- Do not direct air flow at fireplaces or heating apparatus.
- Do not climb on, or place objects on, the air conditioner.
- Do not hang objects from the indoor unit.
- Do not set flower vases or water containers on top of air conditioners.
- Do not expose the air conditioner directly to water.
- Do not operate the air conditioner with wet hands.
- Turn off power source when not using the unit for extended periods.
- Always turn off the electrical breaker whenever cleaning the air conditioner or changing the air filter.
- Connection valves become hot during Heating; handle with care.
- Check the condition of the installation stand for damage.
- Do not place animals or plants in the direct path of the air flow.
- When restarting after a long period of disuse in the winter, turn the power switch on at least 12 hours before starting the unit.
- Do not drink the water drained from the air conditioner.
- Do not use in applications involving the storage of foods, plants or animals, precision equipment, or art works.
- Do not apply any heavy pressure to radiator fins.
- Operate only with air filters installed.
- Do not block or cover the intake grille and outlet port.
- Ensure that any electronic equipment is at least one metre away from either the indoor or outdoor units.
- Avoid installing the air conditioner near a fireplace or other heating apparatus.
- When installing the indoor and outdoor units, take precautions to prevent access by infants.
- Do not use inflammable gases near the air conditioner.

NAME OF PARTS

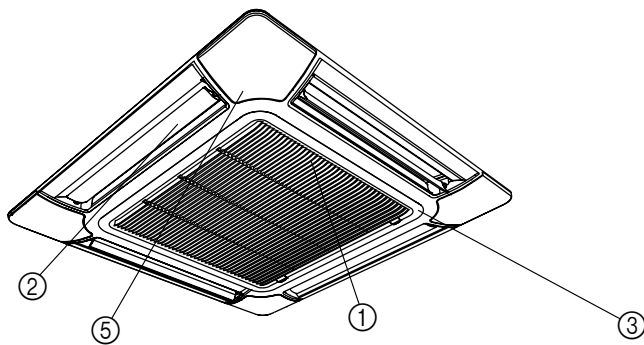

- ① Air Filter (In Air Intake Grille)
- ② Air Flow Direction Flaps
- ③ Air Intake Grille
- ④ Remote Controller (Wired)
- ⑤ Control Panel (OPTION)
- ⑥ Remote Control Signal Receiver
- ⑦ MANUAL AUTO Button
- ⑧ OPERATION Indicator Lamp (Green)
- ⑨ TIMER Indicator Lamp (Orange)
- ⑩ FILTER Lamp (Red)
- ⑪ REMOTE CONTROLLER (Wireless)

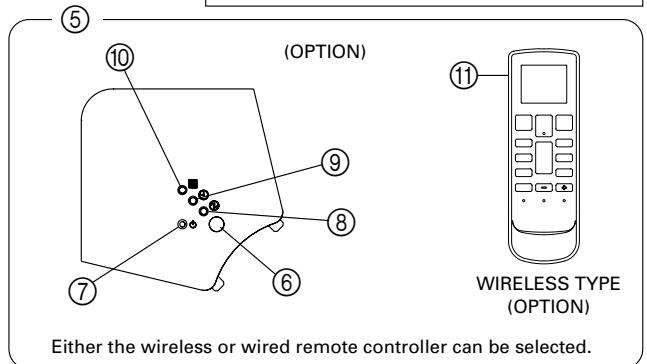
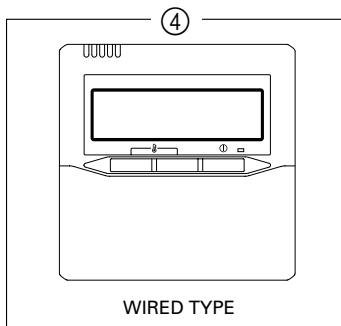

Remote controller

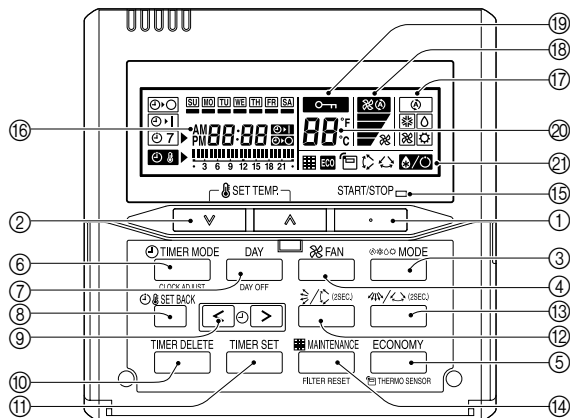

- ① Start/Stop Button
- ② Set Temperature Button
- ③ Master Control Button
- ④ Fan Control Button
- ⑤ Economy Button
- ⑥ Timer Mode (CLOCK ADJUST) Button
- ⑦ DAY (DAY OFF) Button
- ⑧ SET BACK Button
- ⑨ Set Time Button
- ⑩ TIMER DELETE Button
- ⑪ TIMER SET Button
- ⑫ Vertical Airflow Direction and Swing Button
- ⑬ Horizontal Airflow Direction and Swing Button (This function cannot be used)*
- ⑭ Filter Button
- ⑮ Operation Lamp
- ⑯ Timer and Clock Display
- ⑰ Operation Mode Display
- ⑱ Fan Speed Display
- ⑲ Operation Lock Display
- ⑳ Temperature Display
- ㉑ Function Display
- ❄️ Defrost Display
- 🌡️ Thermo Sensor Display
- ECO Economy Display
- ↕️ Vertical Swing Display
- ↔️ Horizontal Swing Display*
- 📊 Filter Display

* These function are not available.

PREPARATORY OPERATION

Set the current day and time

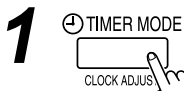

Press the timer mode (CLOCK ADJUST) button for 2 seconds or more. The time display on the remote controller will flash.



Press the DAY button and select the current day. A  appears around the selected day.

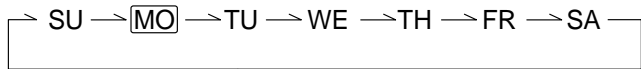

3

Press the set time buttons to set the current time. Press repeatedly to adjust the current time in 1-minute increments. Press and hold to adjust the current time in 10-minute increments.

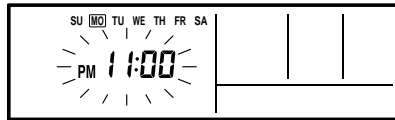
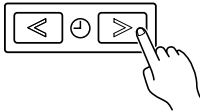

ex. Monday PM 11:00

4



Press the SET BACK button to switch between the 12- and 24-hour time displays.

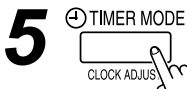

Press again to end.

OPERATION

Instructions relating to heating are applicable only to "HEAT & COOL MODEL" (Reverse Cycle).

To start/stop operation

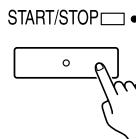

Press the start/stop button.

Operation lamp

Air conditioner ON: Lit brightly
Air conditioner OFF: Not lit

To set the operation mode

● Operation mode setting

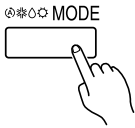

Press the master control button to set the operation mode.
If DRY is selected, the fan speed will be set to AUTO.

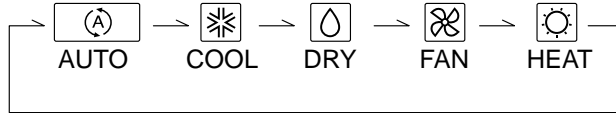

● Room temperature setting

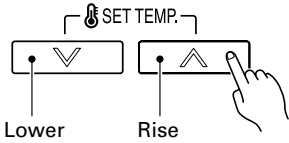

Press the set temperature buttons to set the room temperature.

Temperature setting range

AUTO	18 to 30 °C
COOL/DRY	18 to 30 °C
HEAT	16 to 30 °C

● Fan speed setting



Press the fan control button to set the fan speed.

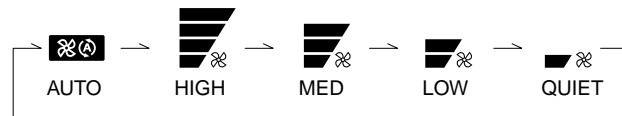

ECONOMY OPERATION

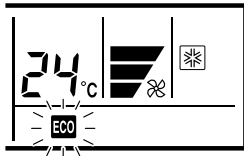

Press the ECONOMY button to start or stop ECONOMY OPERATION.

For details on the function, refer to page 13.

Room temperature sensor selection

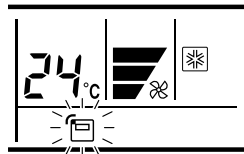

Press the ECONOMY button for more than 2 seconds to select whether the room temperature is detected at the indoor unit (remote sensor) or the remote controller.

When the  thermo sensor display appears, the room temperature is detected at the remote controller.

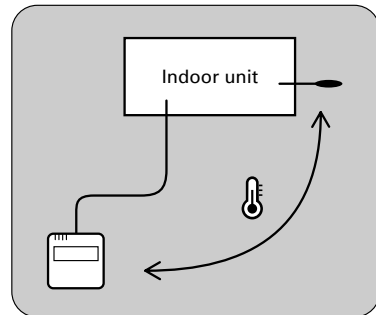

i NOTES



- This function is locked at the factory. In order to detect the room temperature correctly, consult authorized service personnel when using this function.
- If this function is locked, the location where the room temperature is detected cannot be changed and the  mark flashes when the ECONOMY button is pushed for 2 seconds or more.

OPERATION

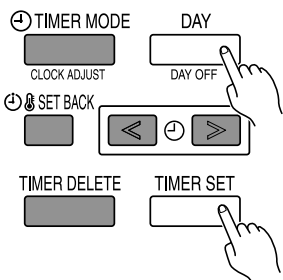
Child lock function



Press the DAY (DAY OFF) button and SET button simultaneously for 2 seconds or more to activate the child lock function and lock all buttons on the remote controller. Press the buttons again for 2 seconds or more to deactivate the child lock function.

When the child lock function is activated, the  mark appears. If any button is pressed during the child lock, the **CL** display and  flash.

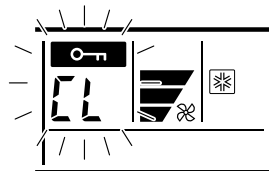

TIMER FUNCTIONS



OFF timer (See page 5.)

Use this timer function to stop air conditioner operation. The timer operates and air conditioner operation stops after the set time has passed. The timer can be set up to 24 hours in advance.



ON timer (See page 5.)

Use this timer function to start air conditioner operation. The timer operates and air condition operation starts after the set time has passed. The timer can be set up to 24 hours in advance.



WEEKLY timer (See page 6.)

Use this timer function to set operating times for each day of the week.

Use the DAY OFF setting to switch off timed operation for a selected day in the coming week.

Because all days can be set together, the weekly timer can be used to repeat the timer settings for all of the days.



Temperature SET BACK timer (See page 8.)

Use this timer function to change the set temperature in the operation times set for each day of the week.

This can be used together with other timer settings.

ON/OFF TIMER

To set the ON/OFF timer

1

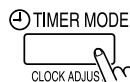

Press the timer mode button to select the ON timer or OFF timer.

2

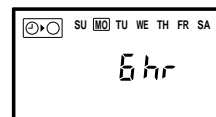
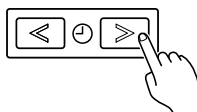

From 1 to 24 hours

ex. OFF timer set for 6 hours

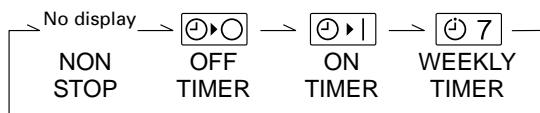

Press the set time buttons to set the time. After the time is set, the timer will start automatically. The amount of time until the OFF timer operates that is displayed on the timer display decreases as time passes.

● To cancel

TIMER DELETE



- Press the DELETE button to cancel the timer mode.
- The timer mode can also be canceled by changing the timer mode using the timer mode button.

WEEKLY TIMER

Weekly timer setting

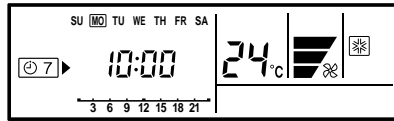
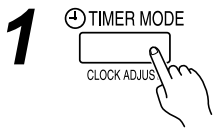

Press the timer mode button to select the weekly timer.

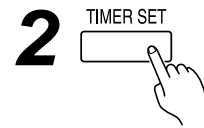

Press the SET button for 2 seconds or more.

3 ● Day of the week setting

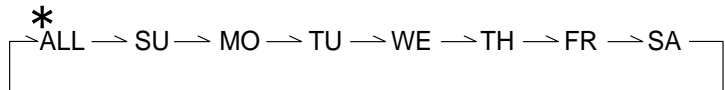
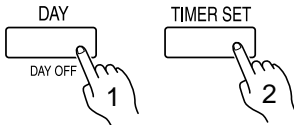

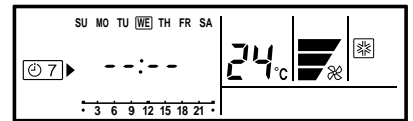

Press the DAY button to select the day of the week, and then press the SET button to confirm the setting.

* For ALL, all of the days can be set together when a appears around each day.

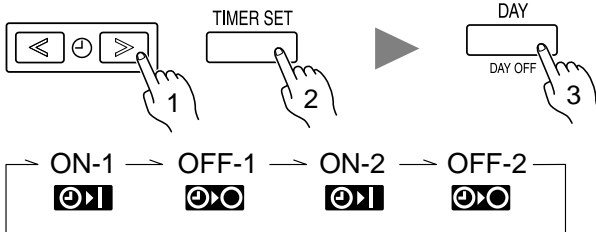

4 ● Time setting



When the operating time is set, the  mark appears.

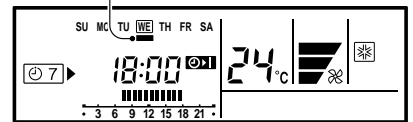

ex. The timer is set for 7:00-18:00.

Press the set time buttons to set the time, and then press the SET button to confirm the setting and proceed to the next ON or OFF time setting. Up to two ON and OFF times can be set per day. Press the DAY button to complete the time setting and return to the day of the week setting.

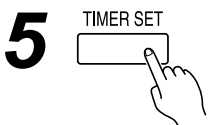

Repeat steps **3** and **4**.
To complete the weekly timer settings, press the SET button for 2 seconds or more.

● To delete the operating time



If the DELETE button is pressed during steps **3** or **4**, the operating time for the selected day will be deleted. If all the days are selected, the operating times for all of the days will be deleted.

I NOTES

- The operating time can be set in 30-minute increments only.
- The OFF time can be carried over to the next day.
- The ON timer and the OFF timer functions cannot be set using the weekly timer. Both an ON and OFF time must be set.

WEEKLY TIMER

WEEKLY timer operation

● To start

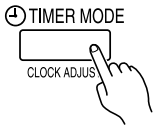

When the weekly timer is selected, the timer starts automatically.

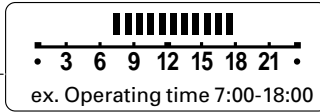
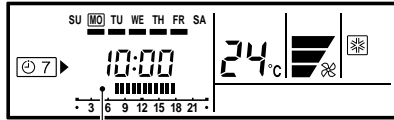

ex. Operating time 7:00-18:00
The operating time for the current day is displayed.

● To cancel



- Press the DELETE button to cancel the timer mode.
- The timer mode can also be canceled by changing the timer mode using the timer mode button.

To set the DAY OFF (for a holiday)

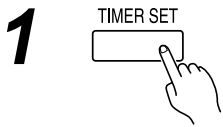

During the weekly timer, press the SET button for 2 seconds or more to set the day.

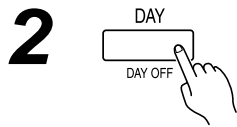

Select the day to set the DAY OFF.

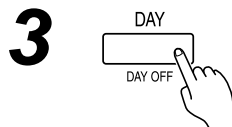

Press the DAY (DAY OFF) button for 2 seconds or more to set the DAY OFF.

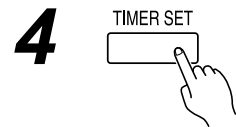

Press the SET button for 2 seconds or more to complete the DAY OFF setting.

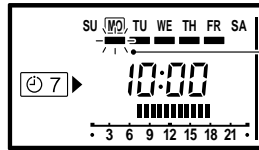
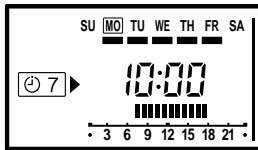

The mark flashes under a day of the week.

ex. The DAY OFF is set for Monday.

● To cancel

Follow the same procedures as those for setup.

NOTES

- The DAY OFF setting is only available for days for which weekly settings already exist.
- If the operating time carries over to the next day (during a next day setting), the effective DAY OFF range will be set as shown below.

● Normal

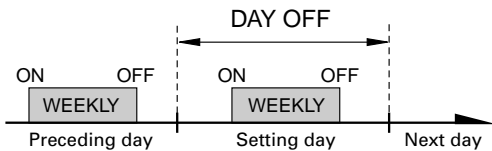

● Next day setting

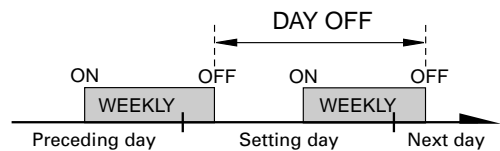

- The DAY OFF setting can only be set one time. The DAY OFF setting is cancelled automatically after the set day has passed.

TEMPERATURE SET BACK TIMER

Temperature SET BACK timer setting

1

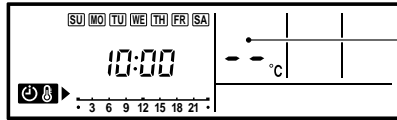

If there is no existing SET BACK temperature setting, "--" will be displayed for the temperature.

Press the SET BACK button to change to the SET BACK confirmation display. The SET BACK operating time and the set temperature will be displayed.

2

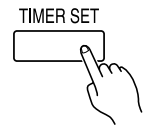

Press the SET button for 2 seconds or more.

3

Day setting

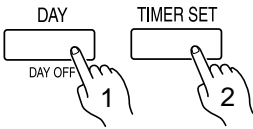

Operating time setting

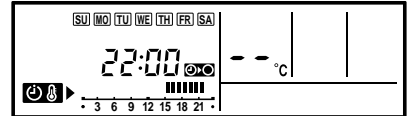
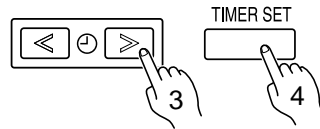

ex. When setting all days together

Follow the same procedures to set the operating time as those for the weekly timer. The DELETE button is also used as described in the procedures for the weekly timer.

4

Temperature setting

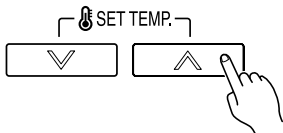

Press the set temperature buttons to set the temperature. (The temperature setting range is the same as the range for the operation mode.)

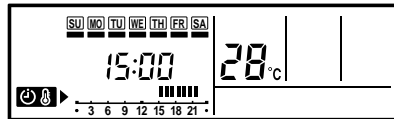

ex. Operating time 15:00–22:00

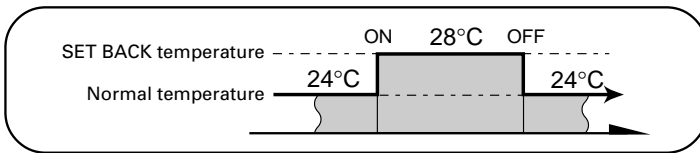

5

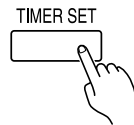

Repeat steps 3 and 4.

Press the SET button for 2 seconds or more to complete the temperature SET BACK timer settings.

Temperature SET BACK timer operation

To start

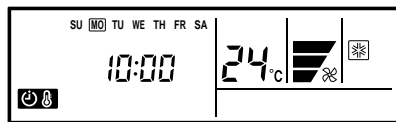

ex. Display during SET BACK timer operation (The operating time will not be displayed.)

Press the SET BACK button. The SET BACK confirmation display appears for 5 seconds, and then the timer starts automatically.

To cancel

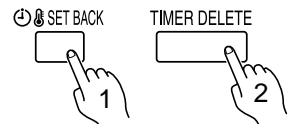

Press the SET BACK button, and then press the DELETE button while the SET BACK confirmation display is displayed. Even if the SET BACK button is pressed again, the SET BACK timer will be cancelled.

NOTES

- The SET BACK timer only changes the set temperature, it cannot be used to start or stop air conditioner operation.
- The SET BACK timer can be set to operate up to two times per day but only one temperature setting can be used.
- The SET BACK timer can be used together with the ON, OFF, and weekly timer functions.
- The SET BACK operating time is displayed only in the SET BACK confirmation display. (Refer to step 1 for the SET BACK confirmation display.)

FILTER DISPLAY RESET

To Reset Filter Display



Press the MAINTENANCE for 2 seconds or more. The filter display will disappear.

SELF-DIAGNOSIS

When "EE" in Temperature Display is displayed, inspection of the air conditioning system is necessary. Please consult authorized service personnel.

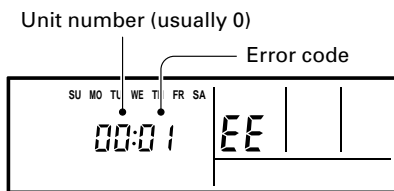

ex. Self-diagnosis check

ADJUSTING THE DIRECTION OF AIR CIRCULATION

Instructions relating to heating (*) are applicable only to "HEAT & COOL MODEL" (Reverse Cycle).

Start air conditioner operation before performing this procedure.

To set the operation mode

● Vertical air direction adjustment

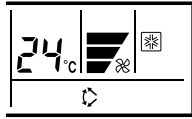
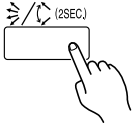

* Press the **START/STOP** button to start the air conditioner, and then proceed as follows.

Press the **VERTICAL AIRFLOW DIRECTION** and **SWING** button to adjust the direction of the vertical airflow.

Each time the button is pressed, the air direction range will change as follows:

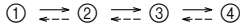

The remote control unit's display does not change.

Recommended Air Flow Direction Setting:

- ①, ②, ③, ④: During Cooling/Dry mode
- ②, ③, ④: During Heating mode

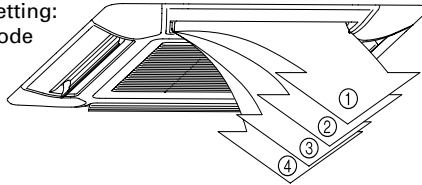

- Attempting to move up/down air direction flaps manually could result in improper operation; in this case, stop operation and restart. The louvers should begin to operate properly again.
- When used in a room with infants, children, elderly or sick persons, the air direction and room temperature should be considered carefully when making settings.

● The vertical airflow direction is set automatically as shown, in accordance with the type of operation selected.

During Cooling/Dry mode : Horizontal flow ①

*During Heating mode : Downward flow ④

● During AUTO mode operation, for the first minute after beginning operation, airflow will be horizontal ①; the air direction cannot be adjusted during this period.

● **Horizontal air direction adjustment.**
The function cannot be used.

SWING OPERATION

Begin air conditioner operation before performing this procedure.

To select/stop swing operation

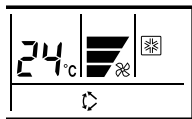
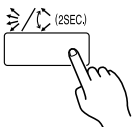

Press the **VERTICAL AIRFLOW DIRECTION** and **SWING** button for more than 2 seconds. (Stop the setting by pressing for more than 2 seconds again.)

About Swing Operation

The type of operation	Range of swing
Cooling/Heating/Dry/Fan	① to ④

● The SWING operation may stop temporarily when the air conditioner's fan is not operating, or when operating at very low speeds.

CLEANING AND CARE



CAUTION!

- Before cleaning the unit, be sure to stop the unit and turn off the electrical breaker.
- A fan operates at high speed inside the unit, and personal injury could result.
- Be careful not to drop the intake grille.

- When used for extended periods, the unit may accumulate dirt inside, reducing its performance. We recommend that the unit be inspected regularly, in addition to your own cleaning and care. For more information, consult authorized service personnel.
- When cleaning the unit's body, do not use water hotter than 40 °C, harsh abrasive cleansers, or volatile agents like benzene or thinner.
- Do not expose the unit body to liquid insecticides or hairsprays.
- If the unit will not be operated for a period of one month or more, be sure to allow the inner parts of the unit to dry thoroughly, in advance, by operating the unit in fan mode for half a day.

Cleaning the Air Filter

When the filter lamp flashes, remove and clean the filter.

1. Push the intake grille's hooks inward towards the center of the unit to open the intake grille.

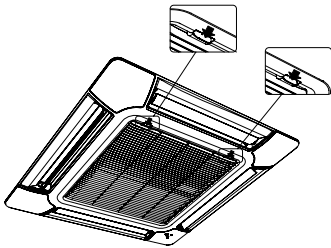

2. Pull out the filter from the intake grille.

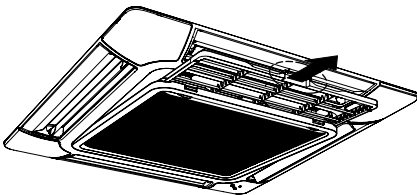

3. Clean the air filter.

Remove the dust from the air filters by vacuuming or washing them. After washing, allow the air filters to dry thoroughly in an area protected from sunlight.

- Dust can be cleaned from the air filter either with a vacuum cleaner, or by washing the filter in a solution of mild detergent and warm water. If you wash the filter, be sure to allow it to dry thoroughly in a shady place before reinstalling.
- If dirt is allowed to accumulate on the air filter, air flow will be reduced, lowering operating efficiency and increasing noise.
- After turning the power on, press the MAINTENANCE button for 2 seconds or more on the remote control.

4. Re-attach the air filters to the intake grille.

- ① Replace the air filter into its holder.
- ② Make sure that the air filter makes contact with the filter stopper when it is replaced into its holder.

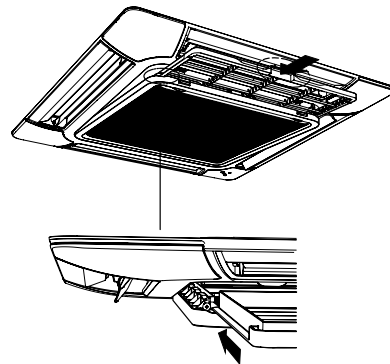

5. Close the intake grille and push the intake grille's hooks outward.

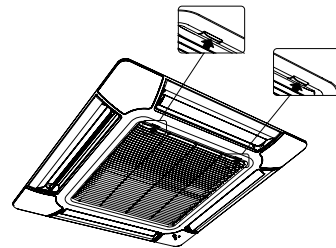

TROUBLESHOOTING



Instructions relating to heating (*) are applicable only to “HEAT & COOL MODEL” (Reverse Cycle).



In the event of a malfunction (burning smell, etc.), immediately stop operation, turn off the electrical breaker, and consult authorized service personnel.

Merely turning off the unit’s power switch will not completely disconnect the unit from the power source. Always be sure to turn off the electrical breaker to ensure that power is completely off.

Before requesting service, perform the following checks:

	Symptom	Problem	See Page
NORMAL FUNCTION	Doesn’t operate immediately:	<ul style="list-style-type: none"> ● If the unit is stopped and then immediately started again, the compressor will not operate for about 3 minutes, in order to prevent fuse blowouts. ● Whenever the electrical breaker is turned off then on again, the protection circuit will operate for about 3 minutes, preventing unit operation during that period. 	—
	Noise is heard:	<ul style="list-style-type: none"> ● During operation and immediately after stopping the unit, the sound of water flowing in the air conditioner’s piping may be heard. Also, noise may be particularly noticeable for about 2 to 3 minutes after starting operation (sound of coolant flowing). ● During operation, a slight squeaking sound may be heard. This is the result of minute expansion and contraction of the front cover due to temperature changes. 	—
		*● During Heating operation, a sizzling sound may be heard occasionally. This sound is produced by the Automatic Defrosting operation.	13
	Smells:	<ul style="list-style-type: none"> ● Some smell may be emitted from the indoor unit. This smell is the result of room smells (furniture, tobacco, etc.) which have been taken into the air conditioner. 	—
	Mist or steam are emitted:	<ul style="list-style-type: none"> ● During Cooling or Dry operation, a thin mist may be seen emitted from the indoor unit. This results from the sudden Cooling of room air by the air emitted from the air conditioner, resulting in condensation and misting. 	—
		*● During Heating operation, the outdoor unit’s fan may stop, and steam may be seen rising from the unit. This is due to the Automatic Defrosting operation.	13
	Airflow is weak or stops:	*● When Heating operation is started, fan speed is temporarily very low, to allow internal parts to warm up.	—
		*● During Heating operation, if the room temperature rises above the thermostat setting, the outdoor unit will stop, and the indoor unit will operate at very low fan speed. If you wish to warm the room further, set the thermostat to a higher setting.	
		*● During Heating operation, the unit will temporarily stop operation (between 4 and 15 minutes) as the Automatic Defrosting mode operates. During the Automatic Defrosting operation,  will be shown on the remote controller display.	13
		● The fan may operate at very low speed during Dry operation or when the unit is monitoring the room’s temperature.	—
● During QUIET operation, the fan will operate at very low speed.		—	
● In the monitor AUTO operation, the fan will operate at very low speed.	—		
Water is produced from the outdoor unit:	*● During Heating operation, water may be produced from the outdoor unit due to the Automatic Defrosting operation.	13	
The FILTER display blinks:	● Clean the filter. Afterwards, turn the FILTER display off.	9, 11	
 thermo sensor display on the remote controller is flashing:	● The room temperature sensor may be malfunctioning. Please consult authorized service personnel.	—	

TROUBLESHOOTING

Instructions relating to heating (*) are applicable only to "HEAT & COOL MODEL" (Reverse Cycle).

	Symptom	Items to check	See Page
CHECK ONCE MORE	Doesn't operate at all:	<ul style="list-style-type: none"> ● Has the circuit breaker been turned off? ● Has there been a power failure? ● Has a fuse blown out, or a circuit breaker been tripped? 	—
		<ul style="list-style-type: none"> ● Is the timer operating? 	5 to 7
	Poor Cooling (or *Heating) performance:	<ul style="list-style-type: none"> ● Is the air filter dirty? ● Are the air conditioner's intake grille or outlet port blocked? ● Did you adjust the room temperature settings (thermostat) correctly? ● Is there a window or door open? ● In the case of Cooling operation, is a window allowing bright sunlight to enter? (Close the curtains.) ● In the case of Cooling operation, are there heating apparatus and computers inside the room, or are there too many people in the room? 	—
		<ul style="list-style-type: none"> ● Is the unit set for QUIET operation? 	—

If the problem persists after performing these checks, or if you notice burning smells, stop operation immediately, disconnect the power supply, and consult with authorized service personnel.

OPERATING TIPS

Instructions relating to heating (*) are applicable only to "HEAT & COOL MODEL" (Reverse Cycle).

*Heating Performance

- This air conditioner operates on the heat-pump principle, absorbing heat from outdoor air and transferring that heat indoors. As a result, the operating performance is reduced as outdoor air temperature drops. If you feel that insufficient heating performance is being produced, we recommend you use this air conditioner in conjunction with another kind of heating appliance.
- Heat-pump air conditioners heat your entire room by recirculating air throughout the room, with the result that some time may be required after first starting the air conditioner until the room is heated.



*When Indoor and Outdoor Temperature are High

- When both indoor and outdoor temperatures are high during use of the heating mode, the outdoor unit's fan may stop at times.

Fan speed: AUTO

- *Heating: The fan will operate at very low speed when the temperature of the air issued from the indoor unit is low.
- Cooling: As the room temperature approaches that of the set temperature, the fan speed becomes slower.
- Fan: The fan runs at the low fan speed.

*Microcomputer-controlled Automatic Defrosting

- When using the Heating mode under conditions of low outdoor temperature and high humidity, frost may form on the outdoor unit, resulting in reduced operating performance. In order to prevent this kind of reduced performance, this unit is equipped with a Microcomputer-controlled Automatic Defrosting function. During the defrost cycle, the indoor fan will shutdown and   will be displayed on the remote controller. It will take anywhere from 4 to 15 minutes before the air conditioner starts up again.

Low Ambient Cooling

- When the outdoor temperature drops, the outdoor unit's fans may switch to Low Speed, or one of the fans may stop intermittently.

*Hot start

The indoor unit prevents cold drafts when heating operation begins. The indoor unit fan will not operate or it will operate at a very low speed until the heat exchanger reaches the set temperature.

About ECONOMY OPERATION

At the maximum output, ECONOMY OPERATION is approximately 70% of normal air conditioner operation for cooling and heating. When ECONOMY OPERATION is performed during the cooling mode, dehumidification is improved. This function is especially convenient when you want to remove the humidity in the room without significantly lowering the room temperature. During ECONOMY OPERATION, the thermostat setting automatically changes according to the temperature to avoid Unnecessary cooling and heating for the most economical operation.

- If the room is not cooled (or heated) well during economy operation, select normal operation.
- During the monitor period in the AUTO mode, the air conditioner operation will not change to ECONOMY OPERATION even if ECONOMY OPERATION is selected by pressing the ECONOMY button.

Dual Remote Controllers (optional)

An additional remote controller can be added up to the maximum of two remote controllers. Either remote controller can control the air conditioner. However, the timer functions cannot be used at the slave unit.

Group Control

One remote controller can control up to 16 air conditioners. All of the air conditioners will be operated with the same settings.

OPERATING TIPS

Mode operation: AUTO

COOLING MODEL

- When the room temperature is 2 °C higher than the set temperature, the mode will switch between Cooling and Drying.
- During the Drying mode operation, the FAN setting should be switched to LOW for a gently cooling effect during which the fan may temporarily stop rotating.

HEAT & COOL MODEL (Reverse Cycle)

Auto changeover function

- When AUTO CHANGEOVER is selected, the air conditioner selects the appropriate operation mode (Cooling or Heating) according to your room's present temperature.
- When AUTO CHANGEOVER is first selected, the fan will operate at a very low speed for about 1 minute while the unit determines the current conditions of the room and selects the proper operation mode.
If the difference between thermostat setting and actual room temperature is more than +2 °C
→ Cooling or dry operation
(Monitor operation may be selected if the outdoor temperature is low.)
If the difference between thermostat setting and actual room temperature is within ±2 °C
→ Monitor operation
If the difference between thermostat setting and actual room temperature is more than -2 °C
→ Heating operation
(Monitor operation may be selected if the outdoor temperature is high.)
- When the room temperature is near the thermostat setting, the air conditioner will begin monitor operation. In the monitor operation mode, the fan will operate at a very low speed. If the room temperature subsequently changes, the air conditioner will once again select the appropriate operation (Heating or Cooling) to adjust the temperature to the value set in the thermostat. (The monitor operation range is ±2 °C relative to the thermostat setting.)

About Mode Operation

Heating: ● Use to warm your room.

- When Heating mode is selected, the air conditioner will operate at very low fan speed for about 3 to 5 minutes, after which it will switch to the selected fan setting. This period of time is provided to allow the indoor unit to warm up before beginning full operation.
- When the room temperature is very low, frost may form on the outside unit, and its performance may be reduced. In order to remove such frost, the unit will automatically enter the defrost cycle from time to time. During Automatic Defrosting operation, and the heat operation will be interrupted.
- After the start of heating operation, it takes sometime before the room gets warmer.

Cooling: ● Use to cool your room.

Dry: ● Use for gently cooling while dehumidifying your room.

- You cannot heat the room during Dry mode.
- During Dry mode, the unit will operate at low speed; in order to adjust room humidity, the indoor unit's fan may stop from time to time. Also, the fan may operate at very low speed when adjusting room humidity.
- The fan speed cannot be changed manually when Dry mode has been selected.

Fan: ● Use to circulate the air throughout your room.

During Heating mode:

Set the thermostat to a temperature setting that is higher than the current room temperature. The Heating mode will not operate if the thermostat is set lower than the actual room temperature.

During Cooling/Dry mode:

Set the thermostat to a temperature setting that is lower than the current room temperature. The Cooling and Dry modes will not operate if the thermostat is set higher than the actual room temperature (in Cooling mode, the fan alone will operate).

During Fan mode:

You can not use the unit to heat and cool your room.

OPERATING TIPS

AUTO Restart

In Event of Power Interruption

- Should the power supply to the air conditioner be interrupted by a power failure, the air conditioner will restart automatically in the previously selected mode once the power is restored.
- Use of other electrical appliances (electric shaver, etc.) or nearby use of a wireless radio transmitter may cause the air conditioner to malfunction. In this event, temporarily disconnect the power supply, reconnect it, and then use the remote control unit to resume operation.

Notice

Instructions relating to heating (*) are applicable only to "HEAT & COOL MODEL" (Reverse Cycle).

- *● During use of the heating mode, the outdoor unit will occasionally commence the defrost operation for brief periods. During the defrosting operation, if the user sets the indoor unit for heating again, the defrosting mode will continue, and the heating operation will begin after completion of defrosting, with the result that some time may be required before warm air is emitted.
- *● During use of the heating mode, the top of the indoor unit may become warm, but this is due to the fact that coolant is circulated through the indoor unit even when it is stopped; it is not a malfunction.

TEMPERATURE AND HUMIDITY RANGE

Permissible ranges of temperature and humidity are as follows:

Cooling/Dry Operation	Outdoor temperature	About -15 °C to 46 °C
	Indoor temperature	About 18 °C to 32 °C
	Indoor humidity	Below approximately 80%. If the air conditioner is used continuously for many hours, water may condense on the surface and drip.
Heating	Outdoor temperature	About -15 °C to 24 °C
	Indoor temperature	About 16 °C to 30 °C

If the unit is used under higher temperature conditions than those noted here, the automatic protection circuit may operate, interrupting the operation.

If the unit is used under lower temperature conditions than those noted here, the heat exchanger may freeze, causing water leakage or other malfunction.

- Do not use the air conditioner for any purpose other than room cooling/dry, room heating or fan.



FUJITSU GENERAL LIMITED
1116, Suenaga, Takatsu-ku, Kawasaki 213-8502, Japan